

Instructions for Use for Qualified Specialists in Orthopaedic Technology System Ankle Joint



NEURO
VARIO-SWING

NEURO VARIO-SWING

Content	Page
1. Information	4
2. Safety Instructions	4
2.1 Classification of the Safety Instructions	4
2.2 All Instructions for a Safe Handling of the System Ankle Joint	4
3. Use	7
3.1 Intended Use	7
3.2 Indication	7
3.3 Contraindication	7
3.4 Qualification	7
3.5 Application	7
3.6 Combination Possibilities with Other System Joints	8
4. Joint Function	8
5. Scope of Delivery	8
6. Load	9
7. Tools for Assembling the System Joint	9
8. Mounting the System Joint	10
8.1 Demounting the Cover Plate	10
8.2 Mounting the Cover Plate	10
8.3 Mounting the System Stirrup	11
8.4 Checking the Free Movement	11
8.5 Mounting the Screw Unit	12
8.6 Mounting the Spring Unit	12
8.7 Securing the Screws	13
9. Adjustment Options on the Orthosis	13
9.1 Adjustable Alignment	14
9.2 Adjustable Range of Motion	14
9.3 Variable Spring Force	14
9.4 Reading the Joint Angles	15
10. Notes on the Production of the Orthosis	15
10.1 Connecting to the System Side Bar/System Anchor	15
10.2 Grinding the Orthosis Parts	15

.....



11. Converting the System Ankle Joint	15
11.1 Conversion Options with plug + go Modularity	16
11.1.1 Conversion with plug + go Modularity	16
11.2 Conversion Options without plug + go Modularity	16
11.2.1 Conversion without plug + go Modularity	16
12. Maintenance	17
12.1 Documentation of Maintenance in the Orthosis Service Passport	18
12.2 Maintenance of the Disc Springs	18
12.3 Replacing the Sliding Washers	19
12.4 Dirt Removal	19
13. Period of Use	19
14. Storage	19
15. Spare Parts	20
15.1 Exploded View Drawing NEURO VARIO-SWING	20
15.2 Spare Parts for the NEURO VARIO-SWING System Ankle Joint with Feather Keys	21
15.3 Spare Parts for the NEURO VARIO-SWING System Ankle Joint without Feather Keys	22
15.4 Spring Units	23
16. Disposal	24
17. Signs and Symbols	24
18. CE Conformity	25
19. Legal Information	25
20. Information for the Treatment Documentation	26
21. Handing Over the Orthosis	27

1. Information

These instructions for use are addressed to qualified specialists in orthopaedic technology and do not contain any notes about dangers which are obvious to them. To achieve maximum safety, please instruct the patient and/or care team in the use and maintenance of the product.

2. Safety Instructions

2.1 Classification of the Safety Instructions

 DANGER	Important information about a possible dangerous situation which, if not avoided, leads to death or irreversible injuries.
 WARNING	Important information about a possible dangerous situation which, if not avoided, leads to reversible injuries that need medical treatment.
 CAUTION	Important information about a possible dangerous situation which, if not avoided, leads to light injuries that do not need medical treatment.
<i>NOTICE</i>	Important information about a possible situation which, if not avoided, leads to damage of the product.

All serious incidents according to Regulation (EU) 2017/745 which are related to the product have to be reported to the manufacturer and to the competent authority of the Member State in which the qualified specialist in orthopaedic technology and/or the patient is established.

2.2 All Instructions for a Safe Handling of the System Ankle Joint

DANGER

Potential Traffic Accident Due to Limited Driving Ability

Advise the patient to gather information about all safety and security issues before driving a motor vehicle with orthosis. The patient should be able to drive a motor vehicle safely.

WARNING

Jeopardising the Therapy Goal by Not Providing the Necessary Free Movement

Check if the system joint moves freely in order to avoid restrictions of the joint function. Use suitable sliding washers according to the information in these instructions for use.

WARNING

Jeopardising the Therapy Goal Due to Incorrectly Adjusted Spring Units

Screw in the spring unit up to the system stirrup and do not preload the spring unit. If the stops are reached too early or too late, either the range of motion is restricted or the patient is not sufficiently stabilised by the orthosis, which worsens the gait.

WARNING

Risk of Falling Due to Improper Processing

Process the system joint according to the information in these instructions for use. Deviating processing and modifications of the system joint require the written consent of the manufacturer.

WARNING

Risk of Falling Due to Permanent Higher Load

If patient data has changed (e.g. due to weight gain, growth or increased activity), recalculate the expected load on the system joint, plan the treatment again and, if necessary, produce a new orthosis.

WARNING

Risk of Falling Due to Incorrectly Selected System Components

Make sure that the system joint and the system components are not overloaded and are functionally adapted to the requirements and needs of the patient in order to avoid joint dysfunction.

WARNING

Risk of Falling Due to Loosened Screws

Mount the cover plate to the system joint according to the assembly instructions in these instructions for use. Secure the screws with the specified torque and the corresponding adhesive and make sure that no sliding washers are damaged in the process.

WARNING

Risk of Falling Due to Improper Shoe/Wrong Shoe Pitch

Advise the patient to wear a shoe to which the orthosis is adjusted in order to avoid joint dysfunction.

WARNING

Risk of Falling Due to Improper Handling

Inform the patient about the correct use of the system joint and potential dangers, especially with regards to:

- moisture and water as well as
- excessive mechanical stress (e.g. due to sports, increased activity or weight gain).

Also inform the patient that the system joint may only be demounted and maintained by a qualified specialist in orthopaedic technology. Any handling of the system joint and the orthosis by the patient that goes beyond the tasks described in the instructions for use for patients is not permitted.

WARNING

Risk of Falling Due to Excessive Readjustment of Spring Units/Screw Units

Adjust the spring units/screw units according to the information in these instructions for use. Do not make readjustments of more than 10°. Use the laser markings on the system stirrup and the joint's upper part to check the readjustment.

WARNING

Damage to the Anatomical Joint Due to Incorrect Position of the Joint's Mechanical Pivot Point

Determine the joint's mechanical pivot points correctly in order to avoid a permanent incorrect load on the anatomical joint. Please refer to the online tutorials on the FIOR & GENTZ website or contact Technical Support.

WARNING

Breakage of System Components Due to Predetermined Breaking Point on the System Stirrup

If you need to file the system stirrup, note all information provided in these instructions for use in order to avoid predetermined breaking points. Grind the system stirrup along the laser lines.

WARNING

Breakage of the System Joint Due to Lack of System Anchor

Use a system anchor when producing the orthosis in order to ensure a secure integration of the system joint into the laminate. The system joint can break if it is integrated without a system anchor.

NOTICE

Limitation of the Joint Function Due to Improper Processing

Errors in processing can impair the joint function. Pay particular attention to:

- correctly connecting the system side bar/system anchor with the system case in accordance with the production technique;
- greasing the joint components only *slightly* and
- adhering to the maintenance intervals.

NOTICE

Limitation of the Joint Function Due to Improper Dirt Removal

Inform the patient on how to properly remove dirt from the orthosis and the system joint.

NOTICE

Limitation of the Joint Function Due to Lack of Maintenance

Respect the specified maintenance intervals in order to avoid joint dysfunction. Also inform the patient about the maintenance appointments to be respected. Enter the next maintenance appointment in the orthosis service passport of the patient.

3. Use

3.1 Intended Use

The FIOR & GENTZ system ankle joints must be used exclusively for the orthotic treatment of the lower extremity. The system joints are only allowed to be used for producing an AFO or a KAFO. Every system joint influences the orthosis' function and thus also the function of the leg. The system joint may only be used for one fitting and must not be reused.

3.2 Indication

The indications for the treatment with an orthosis for the lower extremity are insecurities when standing and walking that lead to a pathological gait. This can be caused, for example, by paralyses, structurally conditioned deformities/malfunctions or as a result of neurological disorders (such as stroke or PAD), physical trauma and/or surgery.

The physical conditions of the patient, such as muscle strength or activity level, are crucial for the orthotic treatment. An evaluation regarding the safe handling of the orthosis by the patient must be carried out.

All system ankle joints can also be used in complement to a prosthetic treatment of patients with partial foot amputations. For this purpose, the orthosis produced for the patient by a qualified specialist in orthopaedic technology (custom-made product) is combined with a foot prosthesis. Further information can be found in the **Guide to Partial Foot Amputations** (see QR code, fig. 1).



fig. 1

Furthermore, all system ankle joints can be used for the treatment of patients with peripheral arterial disease (PAD). For this purpose, the orthosis produced for the patient by a qualified specialist in orthopaedic technology (custom-made product) is combined with a foot orthotic. Further information can be found in the **PAD Guide** (see QR code, fig. 2).



fig. 2

3.3 Contraindication

The system joint is not suitable for treatments that were not described in paragraph 3.2, such as a treatment of the upper extremity or a treatment with a prosthesis or ortho-prosthesis that affects more than just part of the foot, for example after amputations of leg segments.

3.4 Qualification

The system joint must only be handled by a qualified specialist in orthopaedic technology.

3.5 Application

All FIOR & GENTZ system joints were developed for everyday life activities such as standing and walking. Extreme impact stress, which occurs for example during long jump, climbing, parachuting and football, is excluded.

3.6 Combination Possibilities with Other System Joints

The **NEURO VARIO-SWING** system ankle joint can be combined with other system joints from the **FIOR & GENTZ** product range. The system ankle joints **NEURO CLASSIC with plug + go modularity**, **NEURO VARIO-CLASSIC 2** and **NEURO VARIO 2** can be used as supporting joints.

We recommend that you use the Orthosis Configurator when selecting all system components for your orthosis and follow the recommendations of the configuration result.

4. Joint Function

Due to the used system components, the system ankle joint has the following functions:

System Component	Functions
spring unit (dorsal)	<ul style="list-style-type: none"> - determination of the maximum range of motion in plantar flexion - integrated dorsiflexion assist - controlled lowering of the foot during loading response
	motion limiting screw:
	- limitation of the maximum range of motion in plantar flexion
screw units	adjustment of the orthosis' alignment

5. Scope of Delivery

Description	Quantity
system ankle joint (fig. 3)	1
cover plate pressing aid (fig. 4)	1
orthosis joint grease, 3g (without figure)	1
assembly/lamination dummy (fig. 5)	1



fig. 3

The corresponding spring units and system stirrups have to be ordered separately.



fig. 4



fig. 5

6. Load

The actual load on the system joints is based on the relevant patient data. The load and the appropriate system components can be determined by using the Orthosis Configurator. We recommend that you use the system components determined by the Orthosis Configurator when producing an orthosis and mind the recommended production technique. You will find information on the production techniques in the section "Online Tutorials" on the FIOR & GENTZ website.

7. Tools for Assembling the System Joint

Tools for System Joint Screws	System Width				
	10mm	12mm	14mm	16mm	20mm
T10 hexalobular screwdriver/bit	x	-	-	-	-
T15 hexalobular screwdriver/bit	-	x	-	-	-
T20 hexalobular screwdriver/bit	-	-	x	x	-
T30 hexalobular screwdriver/bit	-	-	-	-	x
torque screwdriver, 1–6Nm	x	x	x	x	x
slotted screwdriver, 3.5 x 0.6 x 100mm	x	x	x	x	x
hexagonal screwdriver with spherical head, 4 x 100mm	x	x	-	-	-
hexagonal screwdriver with spherical head, 5 x 100mm	-	-	x	x	x
pliers	x	x	x	x	x

Tools for Pressing Screw	System Width				
	10mm	12mm	14mm	16mm	20mm
T10 hexalobular screwdriver/bit	x	-	-	-	-
T15 hexalobular screwdriver/bit	-	x	-	-	-
T25 hexalobular screwdriver/bit	-	-	x	x	-
T30 hexalobular screwdriver/bit	-	-	-	-	x

8. Mounting the System Joint

The system joint is delivered fully assembled. All functions are checked beforehand. You have to disassemble the system joint for mounting it to the orthosis and for maintenance. To ensure an optimal functioning, follow the assembly instructions below. Secure all screws with the torque specified in paragraph 8.7.

You can find more information on the assembly in the online tutorial **Joint Assembly System Ankle Joints with plug + go Modularity** (see QR code, fig. 6) on the FIOR & GENTZ website.

The assembly is illustrated with the **NEURO VARIO-SWING** system ankle joint as an example.



fig. 6



Only use the FIOR & GENTZ orthosis joint grease to grease the system components.

8.1 Demounting the Cover Plate

- 1 Unscrew both countersunk flat head screws.
- 2 Place the washer on the cover plate and screw the pressing screw into the thread of the first screw (S1; fig. 11). The pressing screw must not be screwed in completely (fig. 7).
- 3 Push the joint's upper part and the cover plate apart by exerting force on them as illustrated (arrows in fig. 7). This can be achieved by using a vice or by controlled knocks (e.g. with a soft-faced hammer).
- 4 Remove pressing screw and washer.

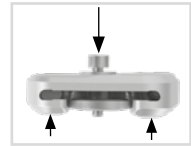

fig. 7



fig. 8

8.2 Mounting the Cover Plate



Make sure not to damage the sliding washer during assembly. Jammed sliding washer particles can cause lateral play in the system joint.

- 1 Before the assembly, clean the thread of the bearing nut and of the joint's upper part as well as the bores of the cover plate with LOCTITE® 7063 Super Clean. Allow the thread to air-dry for 10 minutes.
- 2 Apply spray adhesive on one side of the first sliding washer and adhere it to the cover plate (fig. 8).
- 3 Grease the other side slightly with orthosis joint grease.
- 4 Grease the lateral contact surfaces of the joint's upper part to the cover plate with orthosis joint grease (fig. 9).
- 5 Mount the cover plate by pressing it with the pressing screw and the washer (fig. 10).



fig. 9

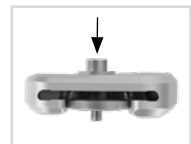

fig. 10

- 6 Remove pressing screw and washer.
- 7 Screw in the first countersunk flat head screw (S1; fig. 11).
- 8 Make sure that there is no opening left between the cover plate and the joint's upper part (fig. 12).

8.3 Mounting the System Stirrup

- 1 Grease the sliding surfaces of the bearing nut as well as the contact surfaces of the system stirrup between system stirrup and spring unit or screw unit with orthosis joint grease.



fig. 11



fig. 12



fig. 13

i Greasing the contact surfaces of the system stirrup is important in order to prevent wear of the system stirrup.

- 2 Grease the second sliding washer slightly on both sides and place it on the system stirrup (fig. 13).
- 3 Slide the system stirrup from below between the cover plate and the joint's upper part. Make sure that the sliding washer points in direction of the joint's upper part and remains in the correct position.
- 4 Place the bearing nut into the intended hollow on the joint's upper part. The bearing nut must be fully inserted in the hollow (fig. 14).
- 5 Screw in the second countersunk flat head screw (axle screw, S2; fig. 15).

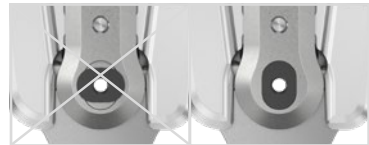

fig. 14

8.4 Checking the Free Movement

Tighten the screws for the cover plate with the appropriate torque (see paragraph 8.7). Check if the system joint moves freely. If the system joint runs with lateral play, mount the next thicker sliding washer. If it does not move freely (it is jammed), mount the next thinner sliding washer.

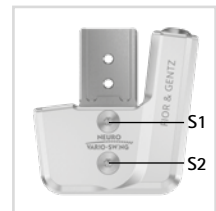

fig. 15

8.5 Mounting the Screw Unit

- 1 Assemble the stop damper/O-ring damper (2) and the sliding bushing (3) with the plunger (1; fig. 16). Make sure that the sliding bushing is correctly positioned on the plunger (fig. 17).
- 2 Put the coil spring (4) on top.
- 3 Insert the plunger (1) including the assembled system components (2, 3, 4) in the spring duct.
- 4 Screw in the alignment screw (5; fig. 16) into the spring duct (fig. 18). Hold the system stirrup to the cover plate so that the system joint is aligned centrally within the degree markings. Screw in the screw unit until the coil spring is completely compressed in the held position of the system stirrup.

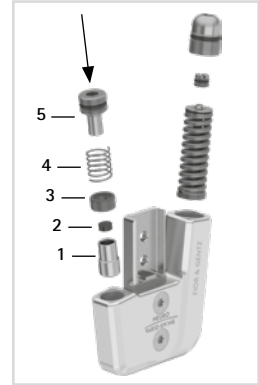

fig. 16



Screw the alignment screw in or out carefully to prevent the coil spring from jumping out unintentionally.

8.6 Mounting the Spring Unit

- 1 Stick the screw unit onto the spring unit (fig. 19).
- 2 Continue with screwing the spring unit for plantar flexion into the posterior spring duct (fig. 20) until it touches the system stirrup. Do not preload the spring unit.

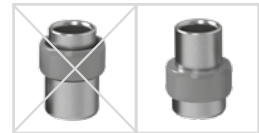

fig. 17



If the O-ring of the screw unit is still visible after you have screwed the spring unit into the system joint, check the adjustment of the system joint and contact Technical Support, if necessary.

- 3 Make sure that there is no play in the system joint. Check this by slightly moving the system joint in the ap direction. Make adjustments, if necessary.
- 4 Make sure that the system joint is aligned within the degree markings.



fig. 18



fig. 19



fig. 20

8.7 Securing the Screws

The screws are secured after the orthosis has been produced and tried on and before it is handed over to the patient.

- 1 Loosen the screws for the cover plate (fig. 15) after checking the free movement and remove them from the cover plate.
- 2 Apply a small drop of LOCTITE® 243 medium strength to the thread of the screws.
- 3 Secure the screws for the cover plate (fig. 15) with the torque corresponding to the system width.
- 4 Let the adhesive harden (final strength after approx. 24 hours).

Screws for Cover Plate	System Width				
	10mm	12mm	14mm	16mm	20mm
pressing screw for cover plate pressing aid	2.5Nm	4Nm	6Nm	6Nm	6Nm
countersunk flat head screw with hexalobular socket (S1)	2.5Nm	4Nm	6Nm	6Nm	6Nm
countersunk flat head screw with hexalobular socket (axle screw, S2)	1.5Nm	3Nm	4Nm	4Nm	6Nm



The screws for the cover plate are not secured with the necessary torque at delivery. You can also find information on the torque in the openings of the cover plate.

9. Adjustment Options on the Orthosis

The orthosis can be individually adapted to the patient's needs with adjustable system ankle joints. The adjustments described do not influence each other and can be made independently of each other.



Mind the correct adjustment of the dorsiflexion stop when mounting the system ankle joint. It is decisive for the entire alignment of the orthosis. You can find more information on this in the online tutorial **AFO Alignment Guidelines** (see QR code, fig. 21) on the FIOR & GENTZ website.



fig. 21

9.1 Adjustable Alignment

The alignment of the orthosis can be adjusted with the alignment screw (1; fig. 22) and the screw unit (4; fig. 22). Note that no more than 10° fine adjustment is allowed. Compress the coil spring in the screw unit (4; fig. 22) when checking the orthosis' alignment. Do not preload the spring unit as this may damage the system joint.

You can increase and decrease the angle between the lower leg and the foot (fig. 23):

- In order to increase the angle in plantar flexion, first unscrew the alignment screw (1; fig. 22). Then, screw in the screw unit (4; fig. 22) until you achieve the required alignment. If necessary, screw in the spring unit further using the alignment screw to prevent play in ap direction.
- In order to decrease the angle in dorsiflexion, unscrew the screw unit (4; fig. 22) until you achieve the required alignment. Then, screw in the alignment screw (1; fig. 22) with the spring unit until there is no more play in ap direction.

The plunger of the screw unit should not lose contact with the system stirrup in the entire range of motion (maximum 15° in plantar flexion) as otherwise noises will occur.

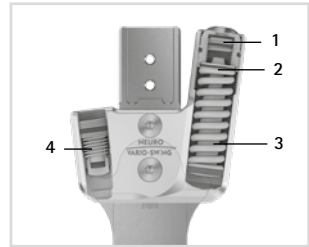

fig. 22

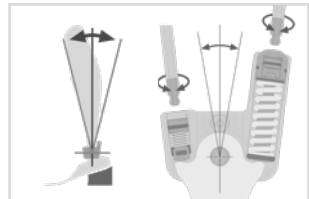

fig. 23

9.2 Adjustable Range of Motion

The range of motion in plantar flexion is infinitely adjustable with the motion limiting screw (2; fig. 22). Each spring unit determines the maximum possible range of motion. They are available for 5°, 10° and 15° range of motion. By screwing in the motion limiting screw, the respective maximum possible range of motion can be limited or completely blocked (fig. 24).

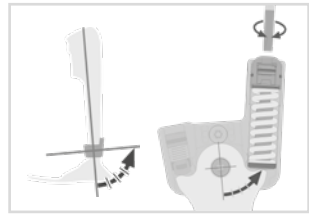

fig. 24

9.3 Variable Spring Force

The spring force can be changed by exchanging the spring units (3; fig. 22). Insert a spring unit into the spring duct that corresponds with the required spring force. There are five spring units with spring forces ranging from normal to extra strong (fig. 25). Note that the spring unit determines the maximum possible range of motion.

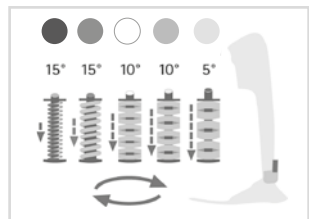

fig. 25

9.4 Reading the Joint Angles

There are markings (fig. 26) on all system joints and system stirrups which indicate the angle of the system components to each other. This allows you to check the individual normal posture (the orthosis' basic alignment), record the joint angle and compare later deviations. The joint angle in the individual normal posture must not be outside the degree markings.

The distances between the degree markings for each system width can be seen in the following table.

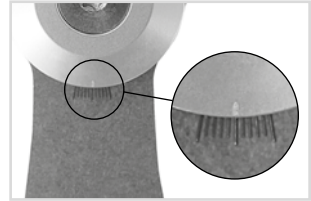

fig. 26

Degree Marking					
System Width	10mm	12mm	14mm	16mm	20mm
Degree	5°	5°	2°	2°	2°

10. Notes on the Production of the Orthosis

10.1 Connecting to the System Side Bar/System Anchor

The system side bar/system anchor must be connected to the system joint by adhering and screwing or screwing and wrapping in accordance with the production technique provided in the planning (fig. 27–29).

You can find more information in the **Instructions for Use for Qualified Specialists in Orthopaedic Technology System Side Bars and System Anchors** (see QR code, fig. 30).



fig. 27



fig. 28



fig. 29

10.2 Grinding the Orthosis Parts

After tempering the orthosis parts, grind the laminate edges. Be careful not to grind the lateral surfaces of the joint's upper part. This can damage the fit between the joint's upper part and the cover plate, which can lead to mechanical noises and to the breakage of the feather keys with pin.

You will find information on the production techniques in the section "Online Tutorials" on the FIOR & GENTZ website.



fig. 30

11. Converting the System Ankle Joint

If you do not need the conversion options, you can completely file off the noses of the system stirrups along the vertical lines (fig. 33).

11.1 Conversion Options with plug + go Modularity

The **NEURO VARIO-SWING** is designed with **plug + go modularity**. System ankle joints with **plug + go modularity** are equipped with identical system stirrups, joint's upper parts and assembly/lamination dummies. There are two categories (system joints with feather keys and system joints without feather keys) and within their category the system joints can be easily converted amongst each other. All functional differences are in the functional unit. You can find more information on the conversion in the online tutorial **Joint Conversion System Ankle Joints with plug + go Modularity** (see QR code, fig. 31) on the **FIOR & GENTZ** website. The following system ankle joints are provided with **plug + go modularity**:

- **NEURO CLASSIC** with **plug + go modularity**
- **NEURO VARIO-CLASSIC 2**
- **NEURO VARIO 2**
- **NEURO VARIO-SPRING 2**
- **NEURO VARIO-SWING**
- **NEURO SWING-CLASSIC**
- **NEURO SWING**
- **NEURO SWING 2**
- **NEURO HiSWING**



fig. 31

11.1.1 Conversion with plug + go Modularity

Step 2 is only necessary for a conversion to the **NEURO HiSWING** system joint.

- 1 Demount the functional unit or the cover plate.
- 2 Mount the spirit level laterally on the lower leg shell.
- 3 Mount the functional unit of the desired system joint in the correct system width (see example fig. 32).

When mounting the functional unit, follow the work steps in paragraphs 8 and 10.2.



fig. 32

11.2 Conversion Options without plug + go Modularity

The **NEURO VARIO-SWING** system ankle joint can also be converted into a **NEURO CLASSIC free moving** by optionally filing the system stirrup and by exchanging the cover plate. There are two categories (system joints with feather keys and system joints without feather keys) and within their category the system joints can be converted amongst each other.

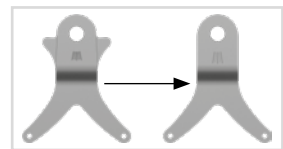

fig. 33

11.2.1 Conversion without plug + go Modularity

- 1 File off the noses along the vertical laser lines completely (fig. 33).
However, this is meant only for visual purposes – the function is also given without filing off the noses.
- 2 Demount the cover plate.
- 3 Mount the cover plate of the system joint **NEURO CLASSIC free moving** in the correct system width (see example fig. 34).

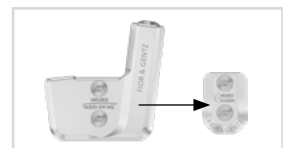

fig. 34

12. Maintenance

Check the system joint regularly for wear and functionality. In particular, check the joint components listed in the following table for the possible problems described and, if necessary, take the appropriate measures. Also check the functionality after every maintenance carried out. It must be possible to move the system joint without problems or unusual noises. Make sure that there is no lateral play and no play around the axis.

Joint Component	Potential Problem	Measure	Recommended Inspection, Potential Replacement*	Latest Replacement
stop damper/ O-ring damper**	wear	replacing stop damper/ O-ring damper	every 6 months	every 18 months
O-ring for securing the alignment screw**	wear	replacing O-ring	every 6 months	every 18 months
O-ring for securing the spring unit	wear	replacing O-ring	every 6 months	every 18 months
spring unit	wear	replacing spring unit	every 6 months	every 18 months
	radial move of disc springs (fig. 37)	realigning disc springs with pliers	every 6 months	every 18 months
	noise of spring unit	greasing spring unit with spray oil (article no. FT3000-15)	every 6 months	every 18 months
coil spring**	wear	replacing coil spring	every 6 months	every 18 months
sliding bushing (screw unit)**	wear	replacing sliding bushing	every 6 months	every 18 months
sliding bushing (system stirrup)	wear	replacing sliding bushing	every 6 months	every 18 months
O-ring for securing the motion limiting screw**	wear	replacing O-ring	every 6 months	every 18 months
sliding washer	wear	replacing sliding washer, see paragraph 12.3	every 6 months	every 18 months
cover plate**	wear	replacing cover plate	every 6 months	every 36 months
countersunk flat head screw with hexalobular socket**	wear	replacing countersunk flat head screw	every 6 months	every 36 months
bearing nut	wear	replacing bearing nut	every 6 months	every 36 months
feather key with pin	breakage	replacing feather key with pin	every 6 months	every 36 months
plunger**	wear	replacing plunger	every 6 months	every 36 months
functional unit***	wear or loss of function	replacing functional unit	every 6 months	every 36 months
system stirrup	wear or breakage	replacing system stirrup	every 6 months	every 48 months

* depending on the assessment of the distributor of the custom-made product regarding the patient's usage behaviour

** is part of the functional unit

*** included system components can be exchanged separately

.....

Clean the thread of the bearing nut and of the joint's upper part as well as the bores of the cover plate with LOCTITE® 7063 Super Clean at every maintenance. Allow the threads to air-dry for 10 minutes.

Secure the screws for the cover plate with the torque corresponding to the system width and LOCTITE® 243 medium strength at every maintenance (see paragraph 8.7). Remove all adhesive residues first.

You can find the individual maintenance plans for system joints in the download area (see QR code, fig. 35) on the FIOR & GENTZ website.



fig. 35

12.1 Documentation of Maintenance in the Orthosis Service Passport

The patient receives an orthosis service passport (fig. 36) from a qualified specialist in orthopaedic technology when the orthosis is handed over. The orthosis must be checked regularly according to the specifications in the maintenance plan in order to maintain its function and to ensure the safety of the patient. The maintenance appointments are noted and confirmed in the orthosis service passport.



fig. 36

12.2 Maintenance of the Disc Springs

Check the disc springs particularly carefully during maintenance (fig. 37–38). We recommend that you grease the disc springs laterally with spray oil (article no. FT3000-15) during every maintenance and realign them, if necessary, to increase the useful life of the spring unit. If necessary, replace the spring unit to maintain the functionality of the system joint.

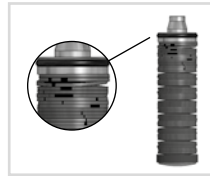

fig. 37

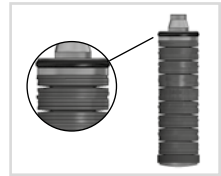

fig. 38

12.3 Replacing the Sliding Washers

Sliding washers are available in different thicknesses (e.g. GS1407-040 is 0.40mm thick). Each thickness has a different marking (fig. 39). You will find the article numbers of the premounted sliding washers on the back page of these instructions for use.

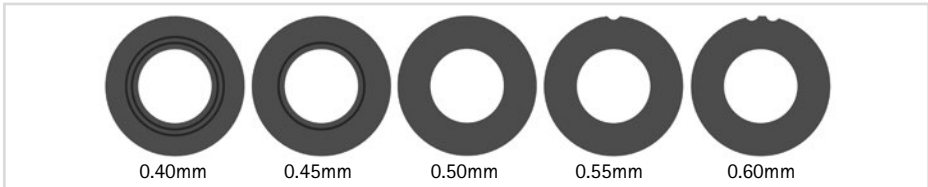

fig. 39

12.4 Dirt Removal

Dirt must be removed from the system joint when necessary and during regular maintenance. For this purpose, disassemble the system joint and clean the soiled system components with a dry cloth.

13. Period of Use

To guarantee a safe use and complete functionality as well as an unlimited period of use of the system joints, you must adhere to the following conditions:

- Adhere to the specified maintenance intervals without interruption and document each maintenance (see paragraph 12).
- Adhere to the determined maintenance conditions (see paragraph 12).
- Check the wear parts, as required, and exchange them at the defined intervals (see paragraph 12).
- Check the adjustment of the system joint during maintenance and correct it if necessary (see paragraph 12).
- Check the functionality of the system joint during maintenance (see paragraph 12).
- The maximum load determined during the planning of the custom-made product shall not be exceeded by changes in the patient data (e.g. due to weight gain, growth or increased activity). If the determined maximum load on the system joints is exceeded, the system joint must no longer be used. When planning the custom-made product, expected changes in patient data need to be taken into account.
- The period of use of the system joints ends with the period of use of the custom-made product (orthosis).
- The multiple use of the system joint in another custom-made product is not allowed (see paragraph 19).

14. Storage

It is recommended to store the system joint in its original packaging until the custom-made product is produced.

15. Spare Parts

15.1 Exploded View Drawing NEURO VARIO-SWING

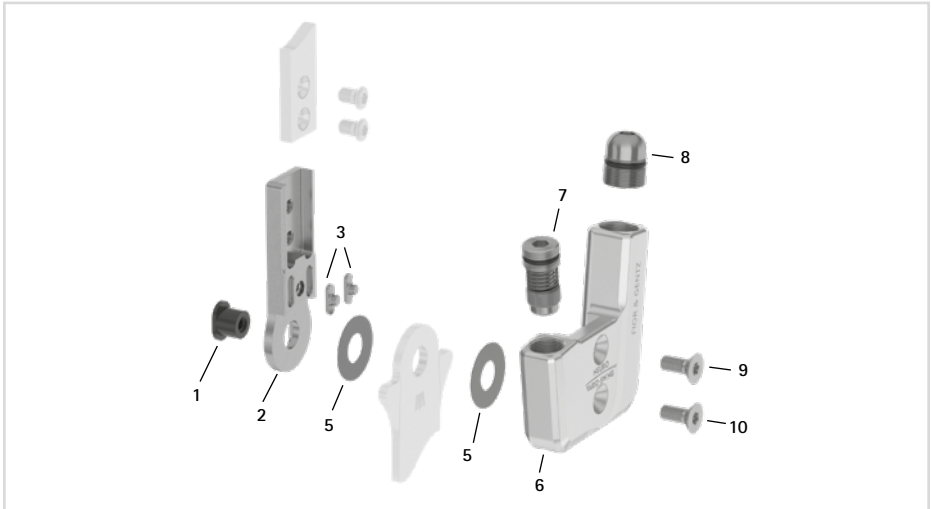

fig. 40

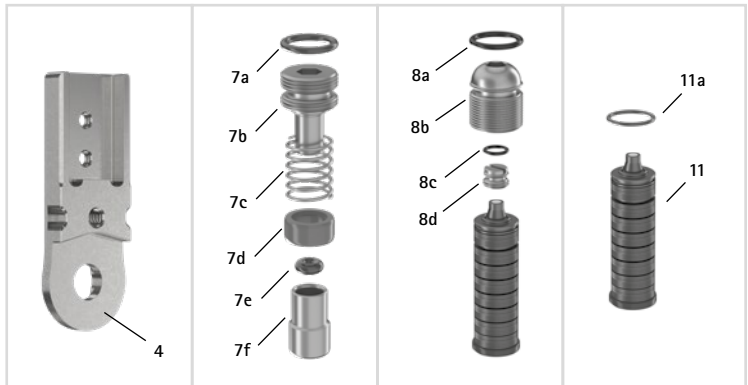

fig. 41

All system stirrups of the system ankle joints are delivered with an integrated sliding bushing.

15.2 Spare Parts for the NEURO VARIO-SWING System Ankle Joint with Feather Keys

Item	Article Number for System Width			Description
	10mm	12mm	14mm	
1	SB6039-L0580	SB7049-L0590	SB8559-L0630	bearing nut
2-3	SF0310-P/ST	SF0311-P/ST	SF0312-P/ST	upper part with feather keys, straight, steel
2-3	-	SF0311-P/TI	SF0312-P/TI	upper part with feather keys, straight, titanium
2-3	SF0330-P/ST	SF0331-P/ST	SF0332-P/ST	upper part with feather keys, bent inwards, steel
2-3	-	SF0331-P/TI	SF0332-P/TI	upper part with feather keys, bent inwards, titanium
2-3	SF0330-8P/ST	SF0331-8P/ST	SF0332-8P/ST	upper part with feather keys, bent outwards, steel
2-3	-	SF0331-8P/TI	SF0332-8P/TI	upper part with feather keys, bent outwards, titanium
3	SF0390-01	SF0391-01	SF0392-02	feather key with pin
5	GS1206-*	GS1407-*	GS2009-*	sliding washer*
6	SH0460-L/AL	SH0461-L/AL	SH0462-L/AL	cover plate, left lateral or right medial
6	SH0460-R/AL	SH0461-R/AL	SH0462-R/AL	cover plate, left medial or right lateral
7	SC9607-L04	SC9608-L06	SC9611-L08	screw unit
7a	VE3771-04/10	VE3771-050/10	VE3771-08/15	O-ring for securing the alignment screw
7b	SC9607-L04/S	SC9608-L06/S	SC9611-L08/S	alignment screw
7c	FE1615-01	FE1611-01	FE1916-01	coil spring
7d	GS0604-350	GS0705-525	GS1007-350	sliding bushing
7e	PN0003-L02	PN0004-L02	-	stop damper
7e	-	-	VE3771-010/20	O-ring damper
7f	SH0490-01	SH0491-01	SH0492-01	plunger
8	SC9609-L13	SC9611-L14	SC9612-L15	screw unit
8a	VE3771-06/11	VE3771-08/15	VE3771-09/15	O-ring for securing the alignment screw
8b	SC9609-L13/S	SC9611-L14/T	SC9612-L15/T	alignment screw
8c	VE3771-03/10	VE3771-04/10	VE3771-04/10	O-ring for securing the motion limiting screw
8d	SC9606-L05	SC9607-L06	SC9607-L06	motion limiting screw
9	SC1403-L08	SC1404-L10	SC1405-L11	countersunk flat head screw with hexalobular socket
10	SC1403-L08	SC1404-L10	SC1405-L11	countersunk flat head screw with hexalobular socket (axle screw)
6-10	SH4970-L/AL	SH4971-L/AL	SH4972-L/AL	functional unit plug + go modularity, left lateral or right medial
6-10	SH4970-R/AL	SH4971-R/AL	SH4972-R/AL	functional unit plug + go modularity, left medial or right lateral

15.3 Spare Parts for the NEURO VARIO-SWING System Ankle Joint without Feather Keys

Item	Article Number for System Width		Description
	16mm	20mm	
1	SB9669-L0760	SB1069-L0960	bearing nut
4	SH0813-ST	SH0815-ST	upper part without feather keys, straight, steel
4	SH0813-TI	SH0815-TI	upper part without feather keys, straight, titanium
4	SH0833-ST	SH0835-ST	upper part without feather keys, bent inwards, steel
4	SH0833-TI	SH0835-TI	upper part without feather keys, bent inwards, titanium
4	SH0833-8/ST	SH0835-8/ST	upper part without feather keys, bent outwards, steel
4	SH0833-8/TI	SH0835-8/TI	upper part without feather keys, bent outwards, titanium
5	GS2210-*	GS2611-*	sliding washer*
6	SH0463-3L/AL	SH0465-3L/AL	cover plate, left lateral or right medial
6	SH0463-3R/AL	SH0465-3R/AL	cover plate, left medial or right lateral
7	SC9612-L08	SC9612-L08	screw unit
7a	VE3771-09/15	VE3771-09/15	O-ring for securing the alignment screw
7b	SC9612-L08/S	SC9612-L08/S	alignment screw
7c	FE1027-01	FE1027-01	coil spring
7d	GS1108-500	GS1108-500	sliding bushing
7e	VE3771-012/26	VE3771-012/26	O-ring damper
7f	SH0493-01	SH0493-01	plunger
8	SC9614-L17	SC9618-L17	screw unit
8a	VE3771-11/15	VE3771-125/15	O-ring for securing the alignment screw
8b	SC9614-L17/T	SC9618-L17/T	alignment screw
8c	VE3771-04/10	VE3771-07/10	O-ring for securing the motion limiting screw
8d	SC9607-L06	SC9611-L06	motion limiting screw
9	SC1405-L12	SC1416-L14	countersunk flat head screw with hexalobular socket
10	SC1405-L12	SC1416-L14	countersunk flat head screw with hexalobular socket (axle screw)
6-10	SH4983-L/AL	SH4985-L/AL	functional unit plug + go modularity, left lateral or right medial
6-10	SH4983-R/AL	SH4985-R/AL	functional unit plug + go modularity, left medial or right lateral

* Sliding Washers

Article Number for System Width				
10mm	12mm	14mm	16mm	20mm
Ø = 12mm	Ø = 14mm	Ø = 20mm	Ø = 22mm	Ø = 26mm
GS1206-040	GS1407-040	GS2009-040	GS2210-040	GS2611-040
GS1206-045	GS1407-045	GS2009-045	GS2210-045	GS2611-045
GS1206-050	GS1407-050	GS2009-050	GS2210-050	GS2611-050
GS1206-055	GS1407-055	GS2009-055	GS2210-055	GS2611-055
GS1206-060	GS1407-060	GS2009-060	GS2210-060	GS2611-060

15.4 Spring Units

Item	Article Number for System Width					Description
	10mm	12mm	14mm	16mm	20mm	
11	SF5800-15/02	SF5801-15/03	SF5802-15/05	SF5803-15/07	SF5805-15/18	spring unit, blue, normal, max. 15° range of motion
11	SF5800-15/04	SF5801-15/06	SF5802-15/11	SF5803-15/15	SF5805-15/25	spring unit, green, medium, max. 15° range of motion
11	SF5800-10/06	SF5801-10/12	SF5802-09/16	SF5803-10/21	SF5805-10/40	spring unit, white, strong, max. 10° range of motion
11	SF5800-10/09	SF5801-10/19	SF5802-10/29	SF5803-10/31	SF5805-10/60	spring unit, yellow, very strong, max. 10° range of motion
11	SF5800-05/17	SF5801-05/33	SF5802-05/53	SF5803-05/63	SF5805-05/99	spring unit, red, extra strong, max. 5° range of motion
11a	VE3771-045/10	VE3771-06/10	VE3771-07/10	VE3771-08/10	VE3771-11/10	O-ring for securing the spring unit

16. Disposal

Dispose of the system joint and its individual parts properly. The product must not be disposed of with the residual waste (fig. 42). Please comply with the applicable national laws and local regulations for the proper recycling of recyclable materials.



fig. 42



For proper disposal, it is necessary to demount the system joint from the orthosis.

17. Signs and Symbols



CE labelling according to Regulation (EU) 2017/745 for medical devices



medical device



article number



manufacturer



batch code



serial number



follow the instructions for use



single patient – multiple uses



Unique Device Identifier – product identification number

18. CE Conformity

We declare that our medical devices as well as our accessories for medical devices are in conformity with the requirements of Regulation (EU) 2017/745. Therefore, the FIOR & GENTZ products bear the CE marking.

19. Legal Information

With the purchase of this product, our General Terms and Conditions of Business Transactions, Sales, Delivery and Payment will apply. The warranty expires, for example, if the product is mounted several times. Please note that the product is not supposed to be combined with other components or materials than with those recommended in the configuration result of the FIOR & GENTZ Orthosis Configurator. The combination of the product with products from other manufacturers is not permitted.

The information in these instructions for use is valid at the date of printing. The contained product information serves as guidelines. Subject to technical modifications.

All copy rights, particularly the distribution, copy and translation of these instructions for use or any part of them, must be authorised by FIOR & GENTZ Gesellschaft für Entwicklung und Vertrieb von orthopädiotechnischen Systemen mbH. Reprints, copies and any other electronic reproduction, even partial, must be authorised in writing by FIOR & GENTZ Gesellschaft für Entwicklung und Vertrieb von orthopädiotechnischen Systemen mbH.

.....

20. Information for the Treatment Documentation

Add these instructions for use to your treatment documentation!

Patient Data

Name	
Address	
Postcode, City	
Home Telephone	
Telephone at Work	
Insurance	
Insurance No.	
Attending Physician	
Diagnosis	

21. Handing Over the Orthosis

The qualified specialist in orthopaedic technology made sure that the instructions for use for patients as well as the orthosis service passport were also handed over with the orthosis to the patient, parents or care team. By means of these instructions for use, the functions and handling of the orthosis were explained to the patient in detail. The next maintenance appointment was entered in the orthosis service passport. The patient was asked to bring the orthosis service passport along to every maintenance appointment.



Leg Side

left right

Mounted Sliding Washers

1. GS _____ - _____

2. GS _____ - _____



PB1600-DE/GB-2026-01

