

patient commission/configuration ID _____

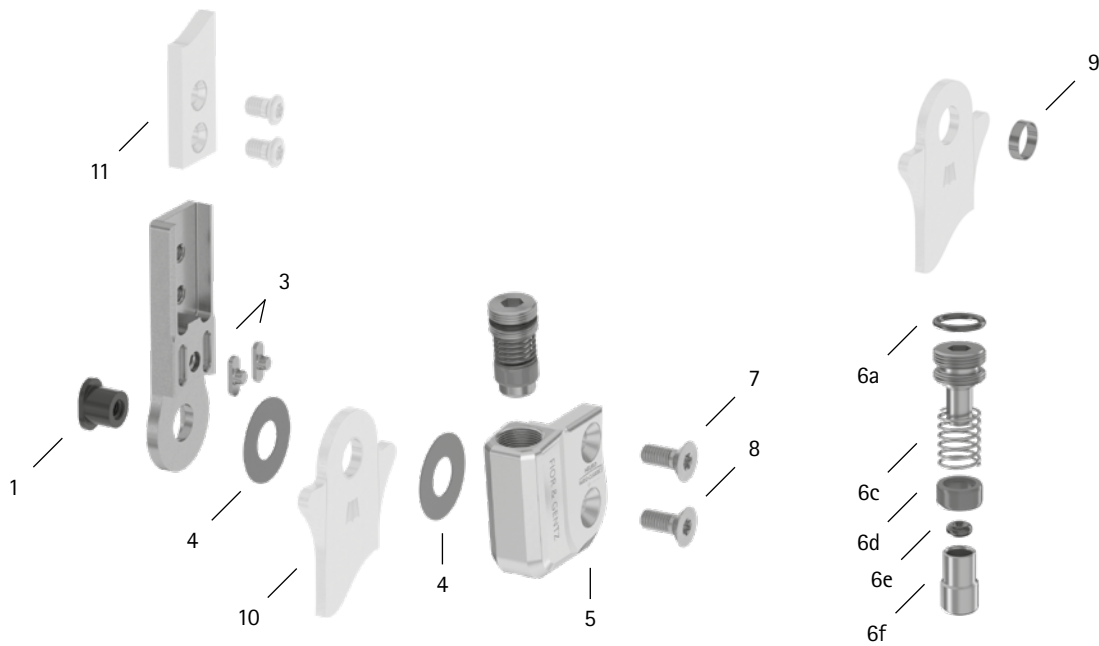

Item	20mm	Description	Potential Problem	Measure	Recommended Inspection, Potential Replacement*	Latest Replacement after
System Joint						
1	SB1069-L0960	bearing nut	wear	wear	every 6 months	36 months
3	SF0395-02	feather key with pin	breakage	replacing	every 6 months	36 months
4	GS2611-040	sliding washer, Ø = 26mm	wear	replacing	every 6 months	18 months
4	GS2611-045					
4	GS2611-050					
4	GS2611-055					
4	GS2611-060					
5	SH0665-L/AL	cover plate, left lateral or right medial**	wear	replacing	every 6 months	36 months
5	SH0665-R/AL	cover plate, left medial or right lateral**	wear	replacing	every 6 months	36 months
6a	VE3771-09/15	O-ring for securing the alignment screw**	wear	replacing	every 6 months	18 months
6c	FE1027-01	pressure spring**	wear	replacing	every 6 months	18 months
6d	GS1108-500	sliding bushing**	wear	replacing	every 6 months	18 months
6e	VE3771-012/26	O-ring damper**	wear	replacing	every 6 months	18 months
6f	SH0493-01	plunger**	wear	replacing	every 6 months	36 months
7	SC1405-L14	countersunk flat head screw with hexalobular socket**	wear	replacing	every 6 months	36 months
8	SC1406-L14	countersunk flat head screw with hexalobular socket (axle screw)**	wear	replacing	every 6 months	36 months
5-8	SH6975-L/AL	functional unit plug + go modularity, left lateral or right medial***	loss of function, wear	replacing	every 6 months	36 months
5-8	SH6975-R/AL	functional unit plug + go modularity, left medial or right lateral***	loss of function, wear	replacing	every 6 months	36 months
System Stirrups, System Anchors and System Side Bars						
9	BR1211-L030	sliding bushing	wear	replacing	every 6 months	18 months
10	see catalogue	system stirrup	wear or breakage	replacing	every 6 months	48 months
11	see catalogue	system anchor and system side bar	wear or breakage	replacing	every 6 months	if required

* depending on the assessment of the distributor of the custom-made product regarding the patient's usage behaviour

** is part of the functional unit

*** included system components can be exchanged separately

WP0059-GB-2024-04