

patient commission/configuration ID _____

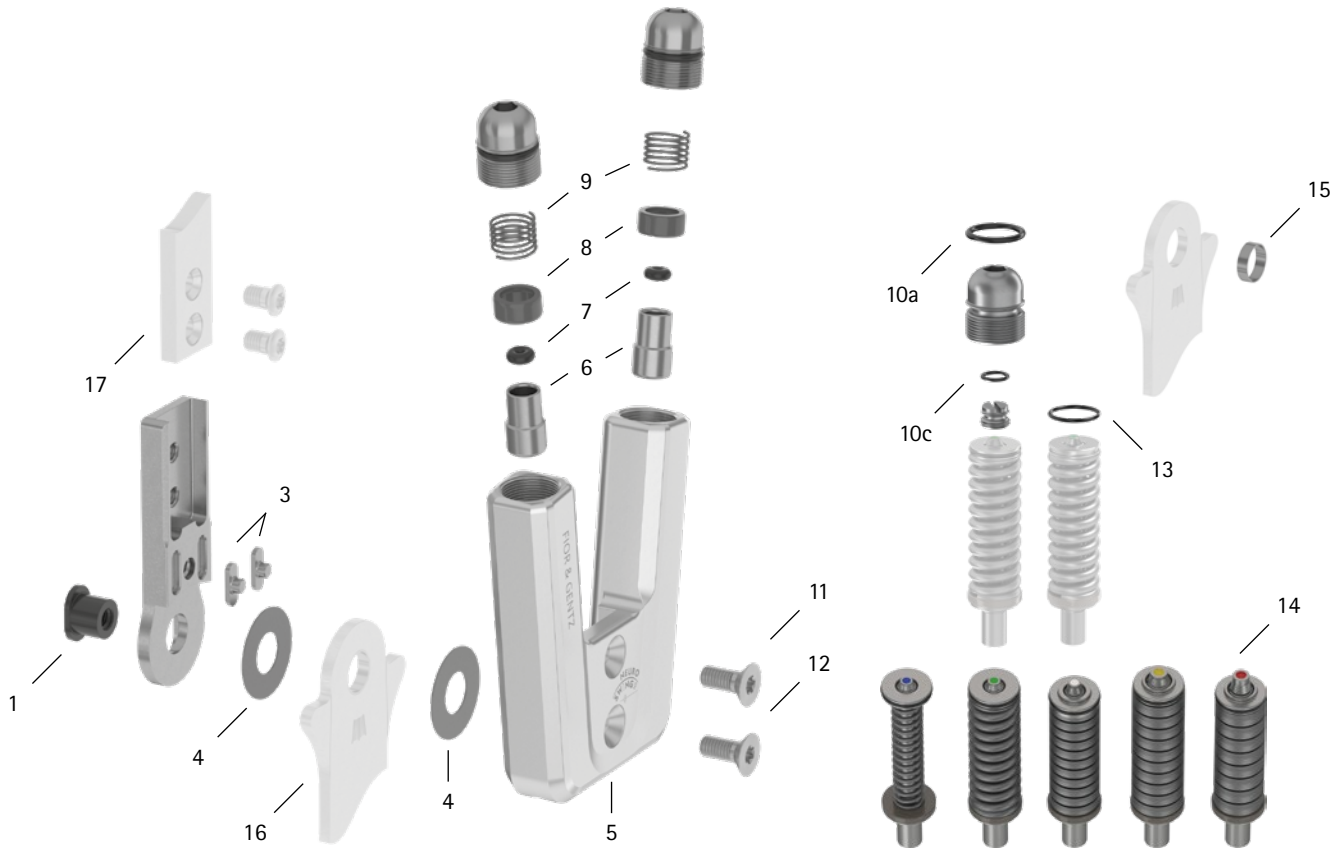

Item	16mm	Description	Potential Problem	Measure	Recommended Inspection, Potential Replacement*	Latest Replacement after
System Joint						
1	SB9669-L0760	bearing nut	wear	replacing	every 6 months	36 months
3	SF0393-02	feather key with pin	breakage	replacing	every 6 months	36 months
4	GS2210-040	sliding washer, Ø = 22mm	wear	replacing	every 6 months	18 months
4	GS2210-045					
4	GS2210-050					
4	GS2210-055					
4	GS2210-060					
5	SH0563-AL	cover plate**	wear	replacing	every 6 months	36 months
6	SH0493-01	plunger**	wear	replacing	every 6 months	36 months
7	VE3771-012/26	O-ring damper**	wear	replacing	every 6 months	18 months
8	GS1108-500	sliding bushing**	wear	replacing	every 6 months	18 months
9	FE1027-01	pressure spring**	wear	replacing	every 6 months	18 months
10a	VE3771-11/15	O-ring for securing the alignment screw**	wear	replacing	every 6 months	18 months
10c	VE3771-04/10	O-ring for securing the motion limiting screw**	wear	replacing	every 6 months	18 months
11	SC1405-L12	countersunk flat head screw with hexalobular socket**	wear	replacing	every 6 months	36 months
12	SC1405-L12	countersunk flat head screw with hexalobular socket (axle screw)**				
5-12	SH5973-AL	functional unit plug + go modularity***	loss of function, wear	replacing	every 6 months	36 months

patient commission/configuration ID _____



Item	16mm	Description	Potential Problem	Measure	Recommended Inspection, Potential Replacement*	Latest Replacement after
Spring Units						
13	VE3771-08/10	O-ring for securing the spring unit	wear	replacing	every 6 months	18 months
14	SH5803-15/07	spring unit, blue, normal, max. 15° range of motion	wear	replacing	every 6 months	18 months
14	SH5803-15/15	spring unit, green, medium, max. 15° range of motion	radial move of disc springs	realigning disc springs with pliers		
14	SH5803-10/21	spring unit, white, strong, max. 10° range of motion	noise of spring unit with coil spring	greasing the coil spring with orthosis joint grease or spray oil (article no. FT3000-15)		
14	SH5803-10/31	spring unit, yellow, very strong, max. 10° range of motion	noise of spring unit with disc springs	greasing disc springs laterally with spray oil (article no.: FT3000-15)		
14	SH5803-05/63	spring unit, red, extra strong, max. 5° range of motion				
System Stirrups, System Anchors and System Side Bars						
15	BR1110-L030	sliding bushing	wear	replacing	every 6 months	18 months
16	see catalogue	system stirrup	wear or breakage	replacing	every 6 months	48 months
17	see catalogue	system anchor and system side bar	wear or breakage	replacing	every 6 months	if required

* depending on the assessment of the distributor of the custom-made product regarding the patient's usage behaviour

** is part of the functional unit

*** included system components can be exchanged separately