

patient commission/configuration ID _____

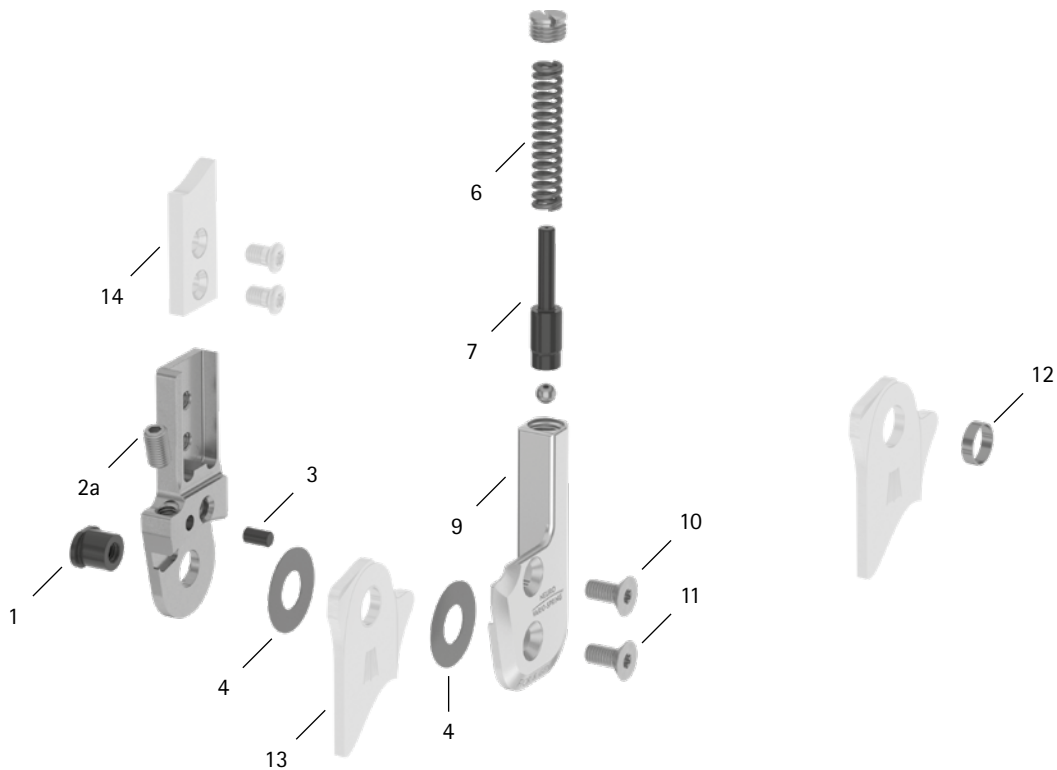

Item	20mm	Description	Potential Problem	Measure	Recommended Inspection, Potential Replacement*	Latest Replacement after
System Joint						
1	SB1069-L0810	bearing nut	wear	replacing	every 6 months	36 months
2a	SC9606-L10ST	adjusting screw	wear	replacing	every 6 months	if required
3	GS4007	securing pin	wear	replacing	every 6 months	if required
4	GS2611-040	sliding washer, Ø = 26mm	wear	replacing	every 6 months	18 months
4	GS2611-045					
4	GS2611-050					
4	GS2611-055					
4	GS2611-060					
6	FE2752-02	pressure spring, golden**	wear	replacing	every 6 months	18 months
7	SF0345-81	pin**	wear	replacing	every 6 months	36 months
9	SF0465-L/AL	cover plate, left lateral or right medial**	wear	replacing	every 6 months	36 months
9	SF0465-R/AL	cover plate, left medial or right lateral**				
10	SC1405-L12	countersunk flat head screw with hexalobular socket**	wear	replacing	every 6 months	36 months
11	SC1406-L12	countersunk flat head screw with hexalobular socket (axle screw)**				
5-11	SF4973-L/AL	functional unit, left lateral or right medial***	loss of function, wear	replacing	every 6 months	36 months
5-11	SF4973-R/AL	functional unit, left medial or right lateral***				
System Stirrups, System Anchors and System Side Bars						
12	BR1211-L030	sliding bushing	wear	replacing	every 6 months	18 months
13	see catalogue	system stirrup	wear or breakage	replacing	every 6 months	48 months
14	see catalogue	system anchor and system side bar	wear or breakage	replacing	every 6 months	if required

* depending on the assessment of the distributor of the custom-made product regarding the patient's usage behaviour

** is part of the functional unit

*** included system components can be exchanged separately